

INDEX FASTENERS™

THE SUPPLY YOU DEMAND™



SCOVILL®
Great Designs Deserve Great Fasteners.

STIMPSON®

ARaymond TINERMAN™
MORE THAN FASTENING



Palnut®

YKK®

TW

H Johnson & Hoffman
precision metal stamping





INDEX FASTENERS™

THE SUPPLY YOU DEMAND™

ITW	1
Johnson & Hoffman	2
ARaymond Tinnerman™	3
ARaymond Tinnerman™ - Palnut®	4
Scovill® Fasteners	5
YKK® Snap Fasteners	6
Stimpson®	7
Standard Hardware	8-10
Machines, Tools & Dies	11
Other Services	12

SCOVILL®
Great Designs Deserve Great Fasteners.



STIMPSON®

ARaymond **TINNERMAN™**
MORE THAN FASTENING



Palnut®

YKK®

Little Parts. Big Difference.

ITW



Johnson & Hoffman
precision metal stamping

TRIM BUTTONS

Ratchet Fasteners

Accordion Type

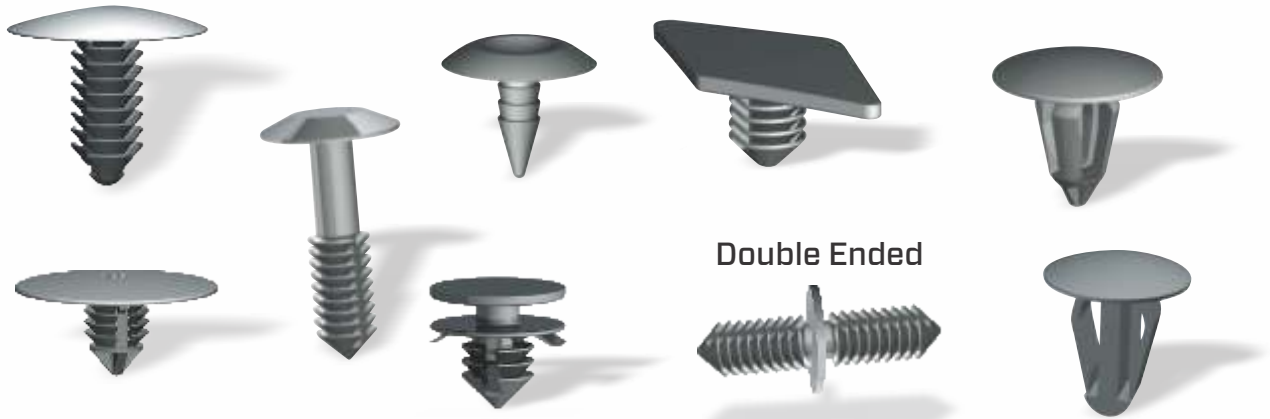

Double Ended

CLIPS & RETAINERS

Cable Retainers

Pipe Clips

Tubing Clips

Wire Retainers

Conduit Retainers

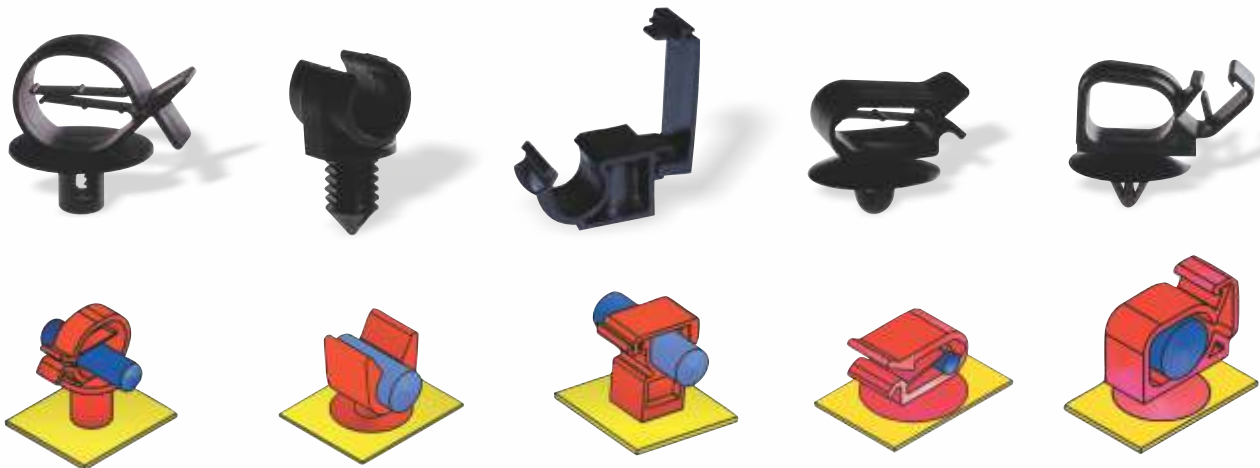

PLUG BUTTONS

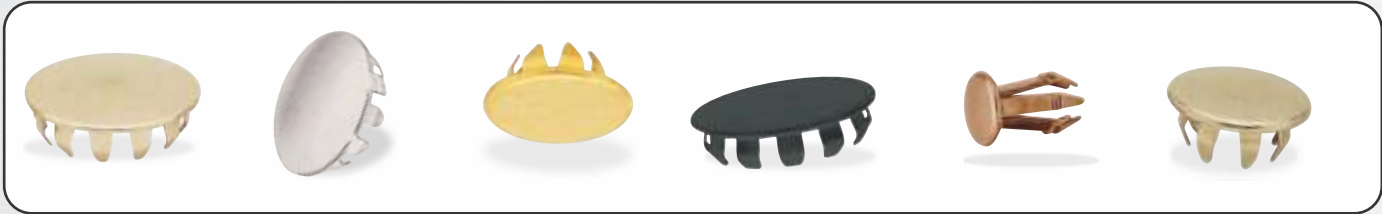

VENTILATOR DRAIN PLUGS



TUBE CLOSURES

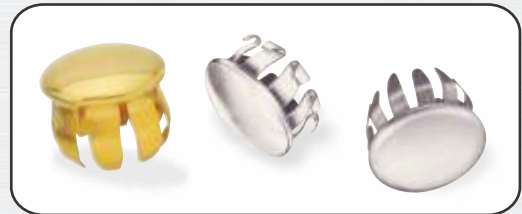

DECORATIVE HUB CAP FASTENERS



CAPPED T-NUTS



FLEXIBLE CONDUIT CONNECTORS



T-NUTS



WELD NUTS



SPEED NUTS

Flat Type



Twin-Type



Expansion Type

U-Type Fasteners

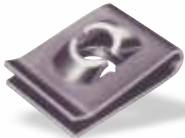

J-Type



NUT RETAINERS

Standard



G-Type



J-Type



U-Type

SPEED CLIP FASTENERS

Ball Stud Type



Tubular Type



Dart Type



CLIP STYLE FASTENERS

U-Type Clips



S-Type Clips

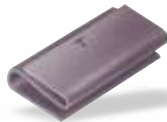

Cable/Wire Clips



Trim-Clip Fasteners



**KNOB TO SHAFT/
COMPRESSION RINGS**



SPECIALS



GROOVELESS RETAINING RINGS



Lock Nut Fasteners

Regular Type



Acorn Type



Wing Type



Inverted Type



PUSHNUT® FASTENERS

Bolt Retainer



Flat Round Type Fasteners



Washer Cap Type Fasteners



Arched Type Fasteners



Acorn Type Fasteners



Colored Cap Type Fasteners



SELF-THREADED TYPES

Capped Washer Type



Acorn Type



Regular & Inverted Type



THREADED U-NUTS

Multi-Thread



Single Thread

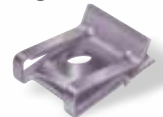

ZIP TWISTS



Regular Type



Washer Type



Self-Threading Type

ON-SERT®



TENSION NUTS



SPLIT RING STYLE 24 & 20 LIGNE



PULL-THE-DOT®



COMMON SENSE™ TURN BUTTONS



LIFT-THE-DOT®



SEGMA® SEGMENTED SOCKET SNAPS



**PRONG RING SNAPS
14, 15, 16 LIGNE**



BUTTONS 22, 27 LIGNE



RIVETS AND BURRS



SPLIT RING STYLE 20 & 24 LIGNE

SK 50®
SK 30®



PARALLEL SPRING SNAP 20 & 24 LIGNE

SW 60®
SW 30®



TWO PRONG SPLIT RING SNAP 20 & 24 LIGNE

SX 700®
SX 300®



PLASTIC SNAPS 14, 16, 20, & 24 LIGNE

SP 100®
SP 75®
SP 70®
SP 60®
SP 50®
SP 30®



SGD SEGMENTED SOCKET SNAPS

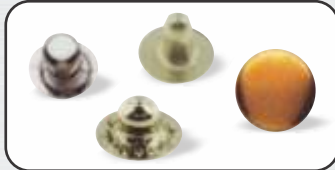

SNAPETD PRONG RING SNAPS 14, 15, & 16 LIGNE

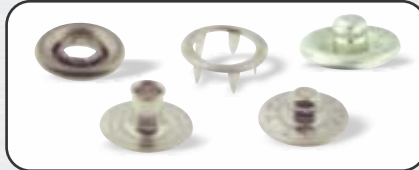

HOOK & EYE

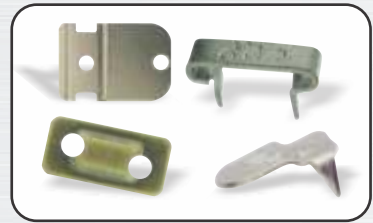

TWO PRONG BURRS RIVET ATTACHED



BUTTONS 22 & 27 LIGNE

JX® Two Prong

JM® Single Track

JM 40® Threaded Track

JP® Nylon Collet

JF® Swivel



ADX/ISO MARKERS



STEEL METAL GROMMETS WITH PLAIN, TOOTH AND NECK WASHERS



ROLLED RIM GROMMETS WITH SPUR WASHERS



SELF-PIERCING GROMMETS & WASHERS



EYELETS



C-E® RIVETS



HOLE PLUGS



Distributor of

Standard Hardware

BOLTS



SPACERS & STANDOFFS



WASHERS



NUTS



Standard Hardware

SCREWS



SOCKET SET SCREWS



SOCKET CAP SCREWS



THREADED ROD



Distributor of

Standard Hardware

CHICAGO SCREWS



BLIND RIVETS



SPEEDY RIVETS



BALL STUDS



STRAP HARDWARE

Plastic

Metal

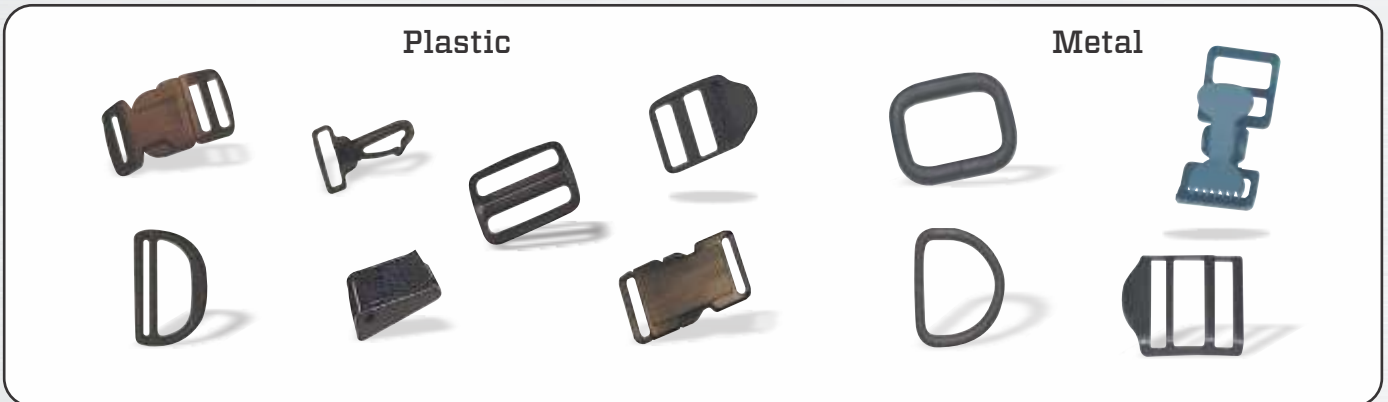

RETAINING RINGS



Machines, Tools & Dies

MANUAL PRESSES



ELECTRIC PRESSES



DIES

*In House Tool & Die Manufacturing Available For Custom Dies



PNEUMATIC PRESSES



AUTOMATIC PRESSES



HAND TOOLS



Other Services

PLATING



CUSTOM MFG.



PATCHING



PACKAGING



NOTES

A large rectangular area with a black border and horizontal lines, intended for handwritten notes.



For over 40 years and throughout three generations we have been a master stocking distributor for the industry's most respected and highest-quality fasteners, injection molded components, and other raw material substrates.

Our partnerships with industry stalwarts are rooted in transparency and loyalty—most have been around since we opened up shop. TRW, ARaymond Tinnerman, Kydex, DOT/Scovill, ITW, Palnut, Stimpson, Johnson & Hoffman, and YKK Snap Fasteners stand proudly in the lineup. Likewise, just like our partnership roster is deep and broad, so is the list of industries we serve. We're proud to impact the aerospace, textile, automotive, marine, construction, military, and medical industries, just to name a few.

President and Owner, Shane Bearly is proud to have helped build Index Industries to become the trusted advice and the fluent translators across companies and industries, a reputation that rests on a resolute determination to provide excellent service to all.

In support of our friends and partners, we are a member of the Industrial Fabrics Association International (IFAI), Pacific Western Fasteners Association (PacWest), Western Association of Fastener Distributors (WAFD), and National Association Wholesale Distributors (NAW) and operate to these organizations' codes of practice. An essential requirement of the continuing maintenance and development of our quality objectives is the implementation and maintenance of a Quality System registered to ISO 9001:2015.



945 Grevillea Court • Ontario, California 91761 • Phone: (909) 923-5002 • Fax: (909) 923-5322

Ph: (800) 230-3964 **Web:** www.indexind.com **e-mail:** sales@indexind.com